

XHIEH CHIN HARDWARE

C1019

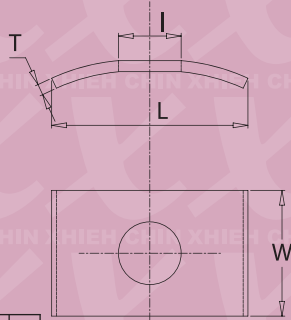

I	L	W	T
5/16"	20	17	1.6

C1019 I*L*W*T

C1023

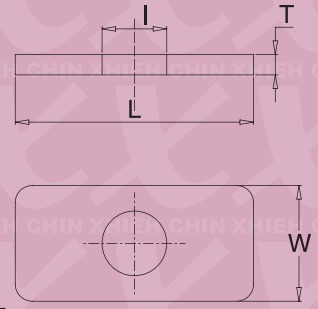

I	L	W	T
9.5	35	17	3.0

C1023 I*L*W*T

C1020

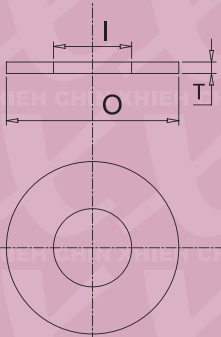

I	O	T
6.5	15	1.0
6.5	16	1.0

C1020 I*O*T

C1024

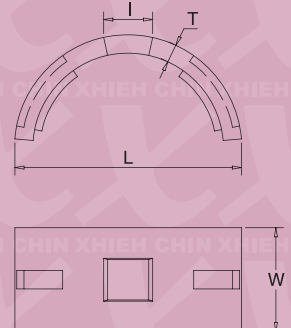

I	L	W	T
6.5	36	16	3.0

C1024 I*L*W*T

C1021

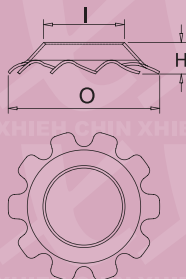

I	O	H
6.5	12	2.5

C1021 I*O*H

C1025

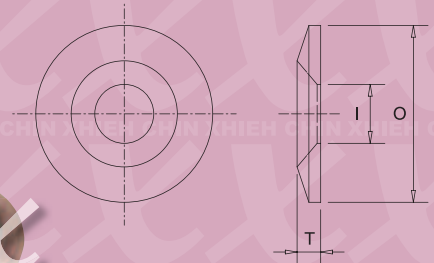

I	O	T
5	15	2.0

C1025 I*O*T

C1022

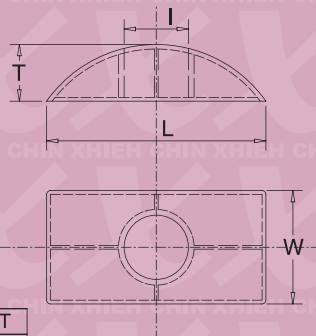

I	L	W	T
5/16"	29	15	8
5/16"	31	15	8.5

C1022 I*L*W*T

D0293

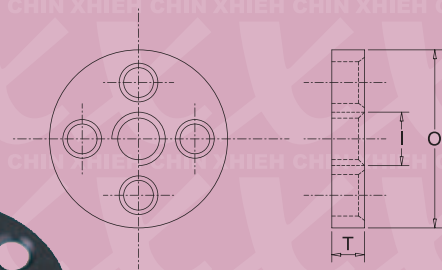

I	O	T
3/8"	50	4

D0293 I*O*T

D0294

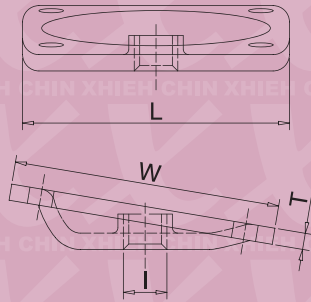

D0294 I*L*W*T

I	L	W	T
5/16"	50	50	3

D0300

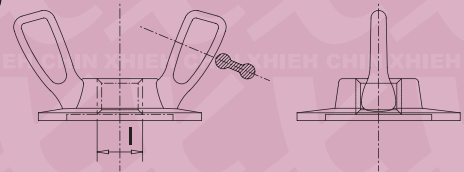

D0300 I

I
1/4"
M5
M6

D0295

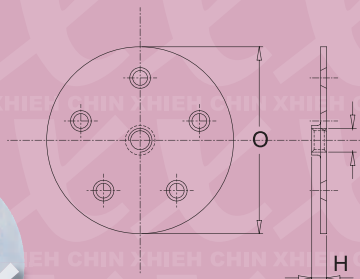

D0295 I*O*H

I	O	H
5/16"	63	5
M8	63	5

D0302

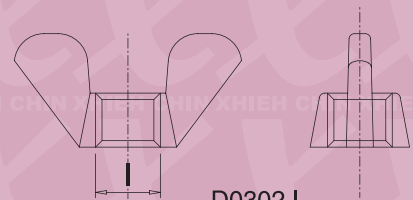

D0302 I

I
M6
M8
1/4"
5/16"

D0297

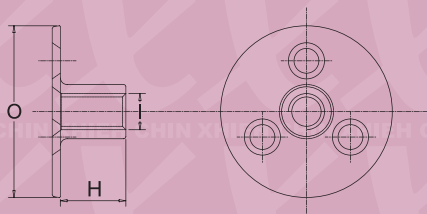
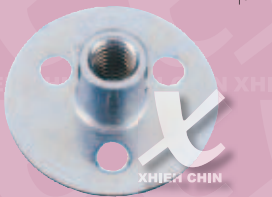

D0297 I*O*H

I	O	H
5/16"(M8)	30,37	15,10
3/8"	37	15

D0304

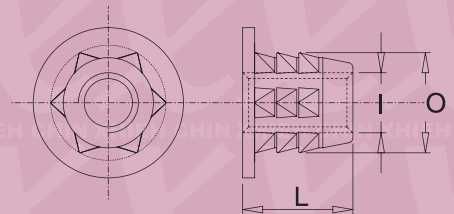

D0304 I*O*L

I	O	L
1/4"(M6)	10,11.5	12,15
5/16"(M8)	12	15
M4	8	9.3

D0298

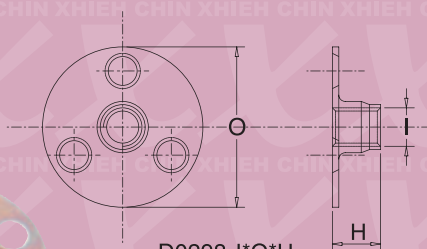

D0298 I*O*H

I	O	H
1/4"	25,37	8
5/16"	30,37	8,10,15
M6	30	5
M8	25,30,37	8,10
3/8"	37	15
3/8"	40	12

D0306

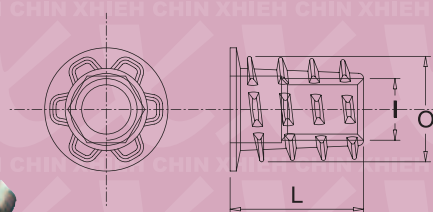

D0306 I*O*L

I	O	L
5/32"	7.5	10
3/16"	10	10,13
1/4"(M6)	10,12	13,15,20,25
5/16"(M8)	13,14	13,18,20,25
3/8"	16.8	25
5/16"	12.7	15,17,20,22
1/4"	10.5	15,20
M5	11.2	9,20

D0307

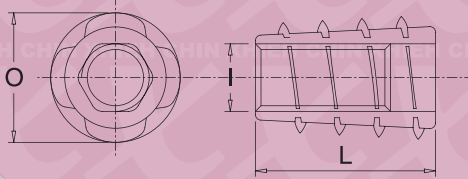

D0307 I*O*L

I	O	L
3/16"	8,10	10
1/4"(M6)	10,12	13,15,20,25
5/16"(M8)	13,14	13,14,15,20,25
3/8"	18	20,30

D0323

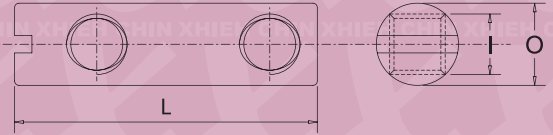

D0323 I*O*L

I	O	L
1/4"(M6)	9.5	35,40,48,53

D0310

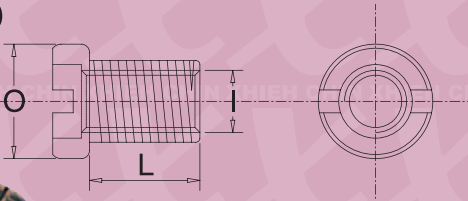

D0310 I*O*L

I	O	L
5/16"	14	12

D0324

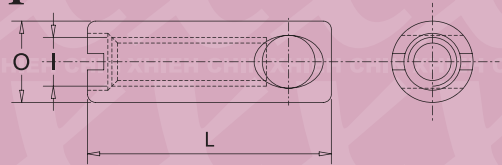

D0324 I*O*L

I	O	L
1/4"(M6)	9	22,30
5/16"(M8)	12	38,45,64

D0311

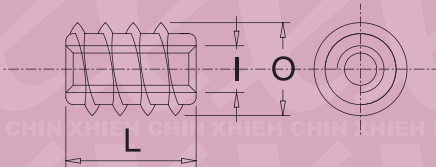

D0311 I*O*L

I	O	L
5/32"(M4)	6	9
3/16"	8.2	9,10,12,15
1/4"(M6)	10,10.5	8,10,12,15,17,20,25
5/16"(M8)	12,12.7	12,14,15,17,20,25,32
3/8"	14.2	15,18,25,45
1/2"		20

D0325

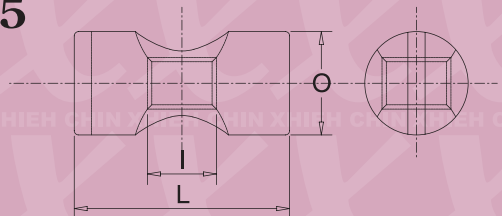

D0325 I*O*L

I	O	L
3/8"	16	19
3/16"	8	10,16
1/4"(M6)	9.5,9.8,10	11,13,14,15,20,25
5/16"(M8)	12	14,15,18,20,25

D0313

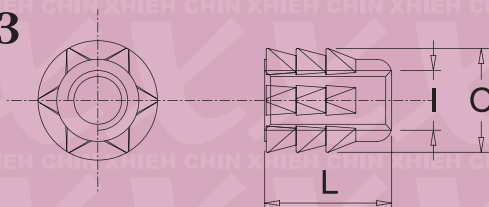

D0313 I*O*L

I	O	L
5/32"(M4)	8.2	10
3/16"(M5)	9.5	10
1/4"(M6)	10.8	10

D0326

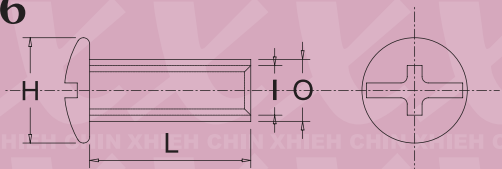

D0326 I*O*L*H

I	O	L	H
M6	8	40	11.5

D0327

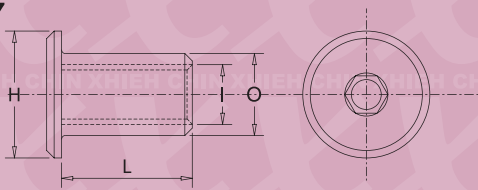

D0327 I*O*L*H

I	O	L	H
3/16"	6,25	10,5	12
1/4"(M6)	9	9,12,14,15,17	13,15,17
5/16"(M8)	11	17	17

D0345

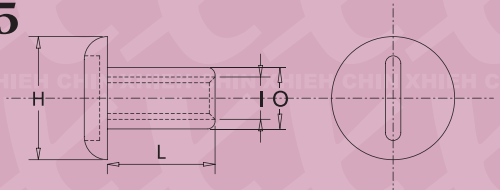

D0345 I*O*L*H

I	O	L	H
1/4	8	15	15.8
1/4	8	14	15

D0328

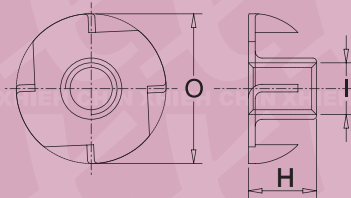

D0328 I*O*H

I	O	H
3/16"(M5)	15	8
1/4"(M6)	18	10,14
5/16"(M8)	22	10
3/8"(M10)	25	12
M4	15	6

D0346

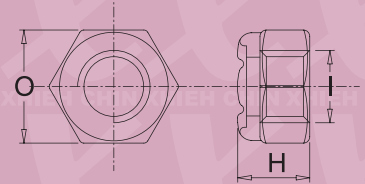

D0346 I*O*H

I	O	H
1/4"	11	8
5/16"(M8)	12.5	8.8
3/8"	14	11.5
M6	10	6
M8	13	8
M12	19	9,12

D0329

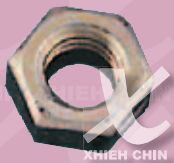
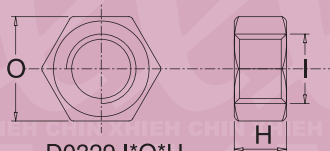

D0329 I*O*H

I	O	H
5/32"	8	3,7
3/16"(M5)	8	4
1/4"(M6)	10	5
5/16"	12,14	6,6,5
3/8"	14	7
7/16"	17	8,9
1/2"	19	8,5,10,5
5/8"	23,5	13,5
M8	12,13	6,2,6,5
M10	14	8
M15	24,87	12
M16	23	8
M18	26,30	10

D0347

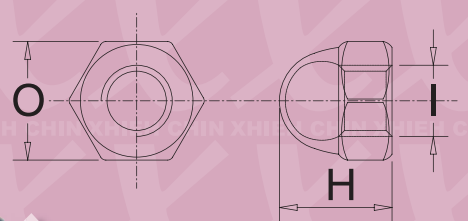

D0347 I*O*H

I	O	H
5/32"	8	7.6
3/16"(M5)	8	7.6
1/4"(M6)	10	9.8,12
5/16"(M8)	12	12

D0331

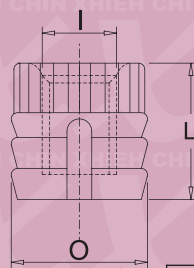

I	O	L
M6	11	11

D0331 I*O*L

D1001

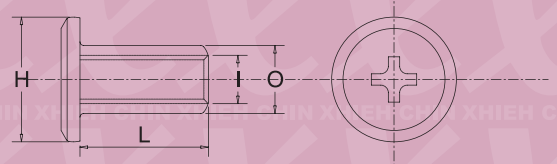

D1001 I*O*L*H

I	O	L	H
M6	8	12	13
M6	8	14	16
1/4"	9	17	17

D1002

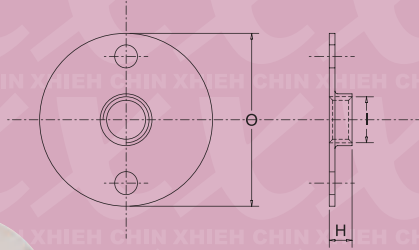

D1002 I*O*H

I	O	H
5/16"	30	4

D1007

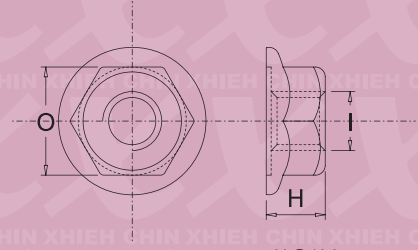

D1007 I*O*H

I	O	H
1/4"(M6)	10	6
5/16"(M8)	17	17

D1003

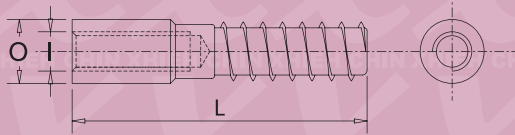

D1003 I*O*L

I	O	L
3/16"	6	31
1/4"	8	25
1/4"	8	30
1/4"	8	38

D1008

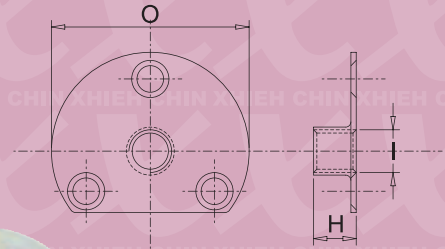

D1008 I*O*H

I	O	H
5/16"	30	8

D1004

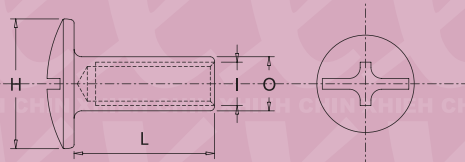

D1004 I*O*L*H

I	O	L	H
1/4"	9	13	12

D1009

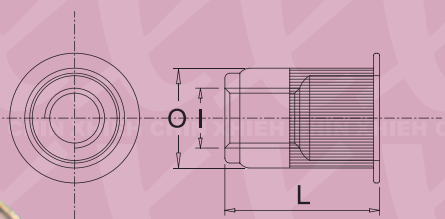

D1009 I*O*L

I	O	L
1/4	9.8	15
M6	8.9	15

D1006

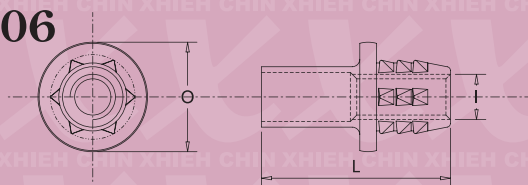

D1006 I*O*L

I	O	L
1/4"	14.5	25
M6	14.5	25

D1010

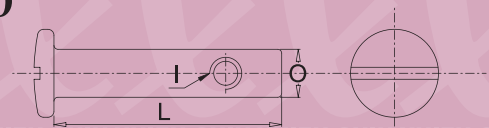

D1010 I*O*L

I	O	L
5/16"	12	57

D1011

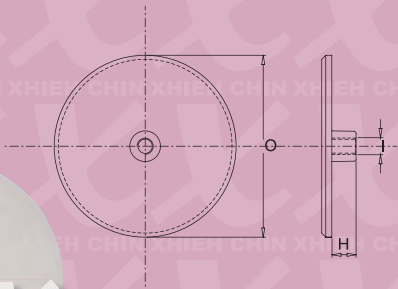

D1011 I*O*H

I	O	H
5/16"	89	12

D1015

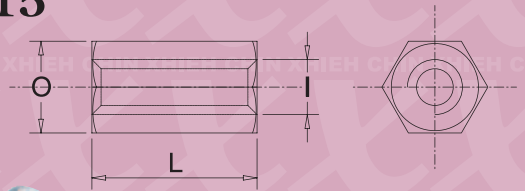

D1015 I*O*L

I	O	L
5/16"	13	18
1/4"	10	22
M6	10	18
M8	12.5	12.5

D1012

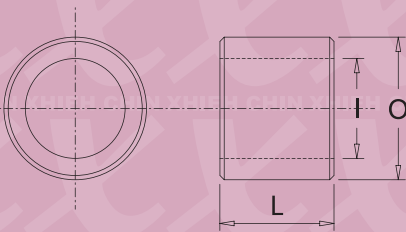

D1012 I*O*L

I	O	L
7	10	8

D1016

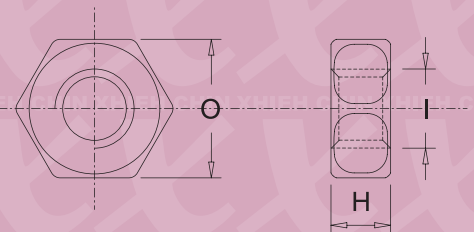

D1016 I*O*H

I	O	H
5/32"	6	2

D1013

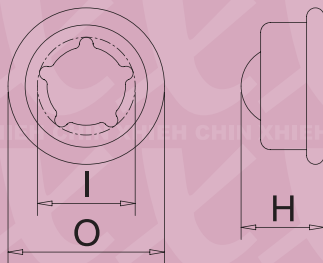

D1013 I*O*H

I	O	H
8	16	8.8

D1017

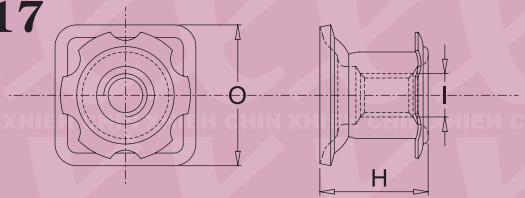
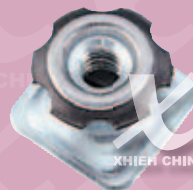

D1017 I*O*H

I	O	H
1/4"	19.5	15
M6	25	25

D1014

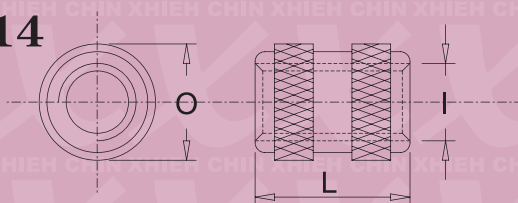

D1014 I*O*L

I	O	L
5/32"	6	8.4

D1018

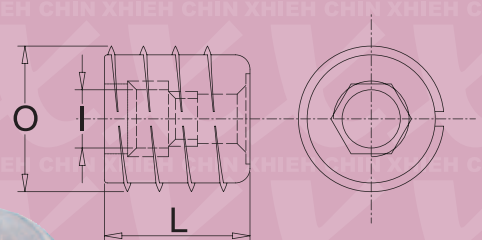

D1018 I*O*L

I	O	L
M8	25	13,26
3/8"	25	26

D1019

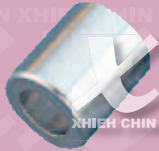
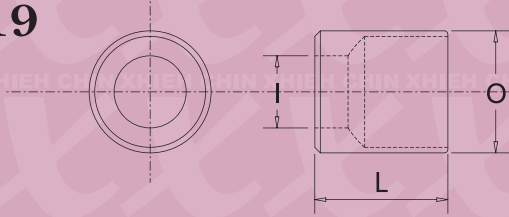

D1019 I*O*L

I	O	L
6	12.2	11

D1023

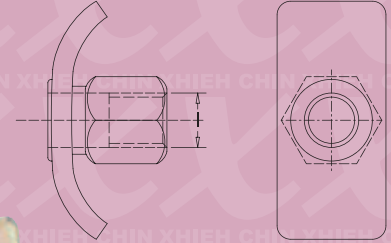

D1023 I

I
5/16"(M8)

D1020

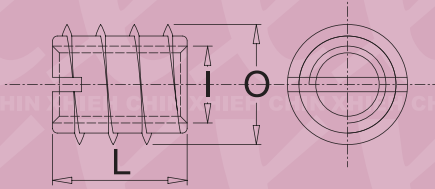

D1020 I*O*L

I	O	L
M4	8	10
1/4"(M6)	10.5	12,13,15
5/16"(M8)	12.5,12.7	14,17,20,25

D1024

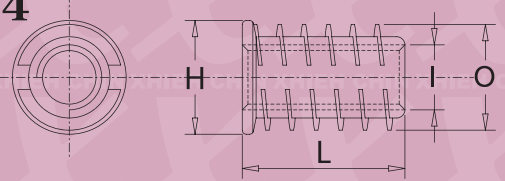

D1024 I*O*L*H

I	O	L	H
M8	13	20	14

D1021

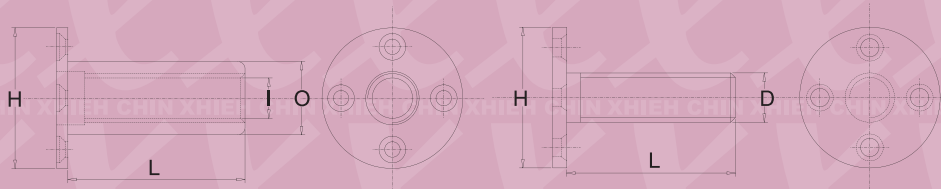

D1021 I*O*L*H

I	O	L	H
17	26	67	50

D1021 D*L*H

D	L	H
17	60	50

D1022

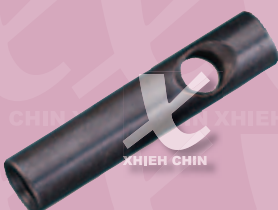
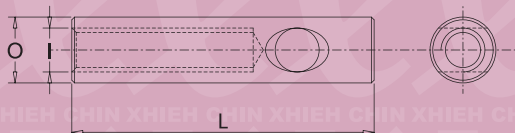

D1022 I*O*L

I	O	L
1/4"(M6)	9.5	30,40
5/16"	12	45,55

D1026

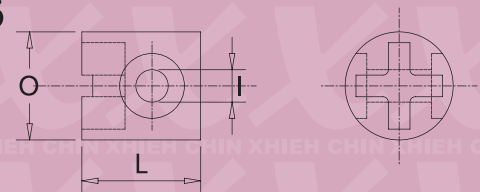

D1026 I*O*L

I	O	L
3	10	11
3.5	10	13.5

D1027

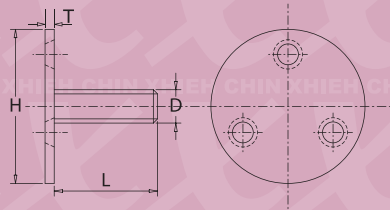

D1027 D*L*H*T

D	L	H	T
M8	13	50,63,80	2.5
M8	25	37	2.5

D1032

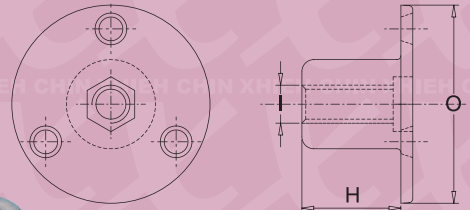
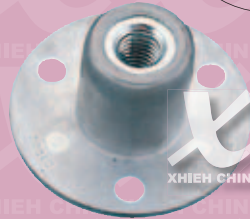

D1032 I*O*H

I	O	H
3/8"	50	27.5

D1028

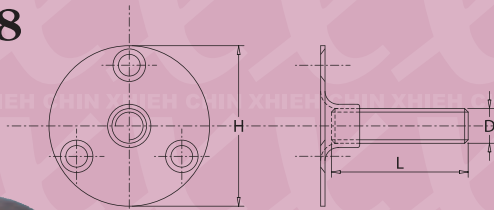

D1028 D*L*H

D	L	H
5/16"	8.5	37

D1033

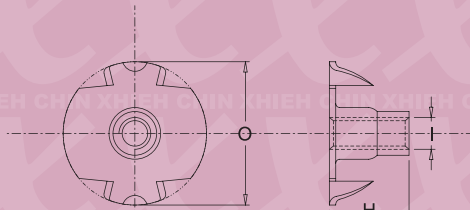

D1033 I*O*H

I	O	H
8#-32	18	10.4

D1029

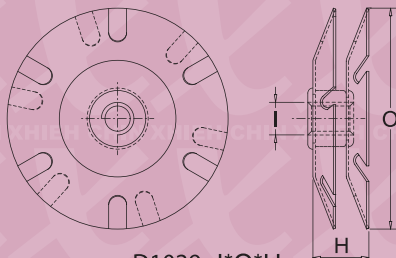

D1029 I*O*H

I	O	H
1/4"	43.2	10
1/4"	34.0	10

D1034

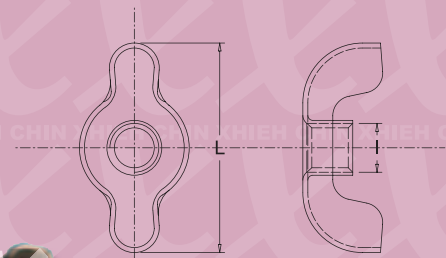

D1034 I*L

I	L
M5	22

D1030

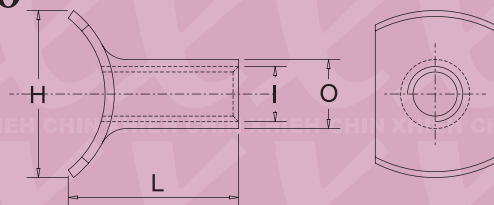

D1030 I*O*L*H

I	O	L	H
1/4	7.6	15	18

D1035

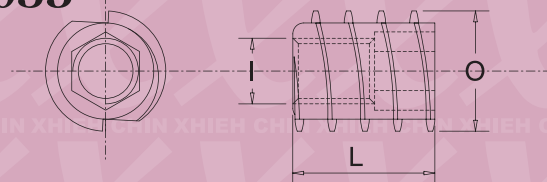

D1035 I*O*L

I	O	L
M6	10	13

D1036

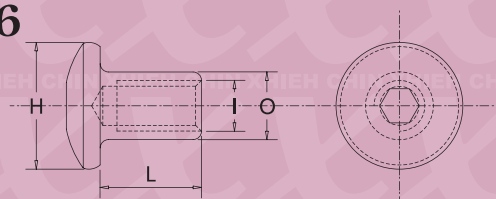

D1036 I*O*L*H

I	O	L	H
M6	8	12	15

D1040

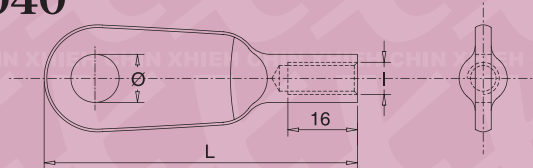

D1040 I*L*Ø

I	L	Ø
M8	58	9.1

D1037

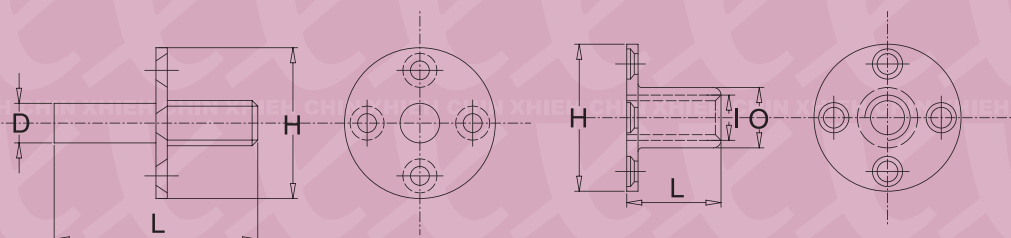

D1037

D	L	H
1/2"	54	40

I	O	L	H
1/2"	16	25	40

D1038

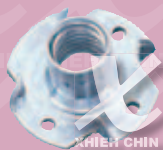
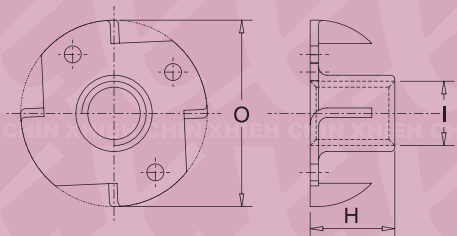

D1038 I*O*H

I	O	H
1/4"	18	10
5/16"	22	12

D1041

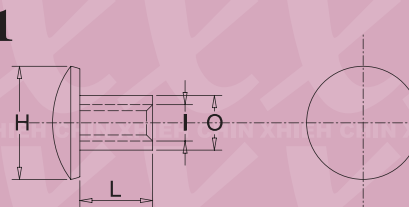

D1041 I*O*L*H

I	O	L	H
1/4"	9	12	18

D1039

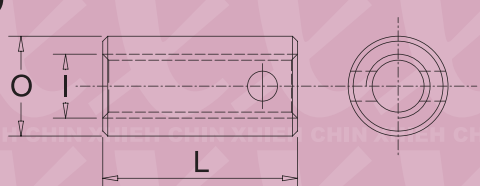

D1039 I*O*L

I	O	L
M6	8	25

D1042

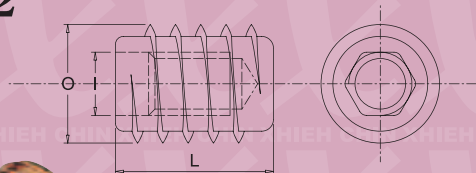

D1042 I*O*L

I	O	L
M8	15.2	30
5/16"	15	30

D1044

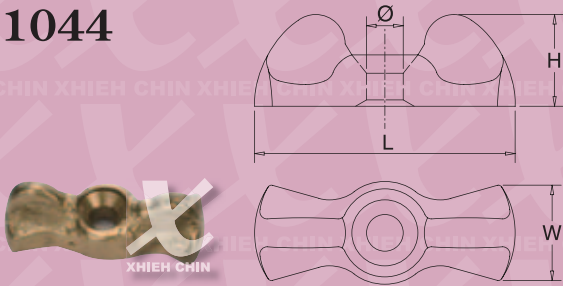

D1044 Ø*L*W*H

Ø	L	W	H
5	35	13	12

D1052

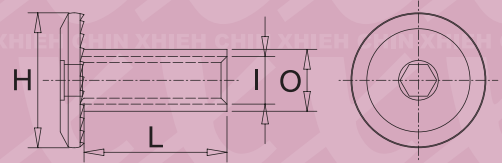

D1052 I*O*L*H

I	O	L	H
M6	7.8	18	17

D1049

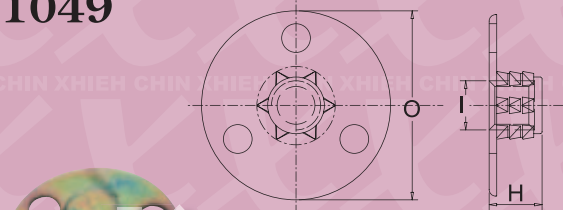

D1049 I*O*H

I	O	H
1/4"	25	7

D1053



D1053 I*O*L

I	O	L
1/4	10	160

D1050

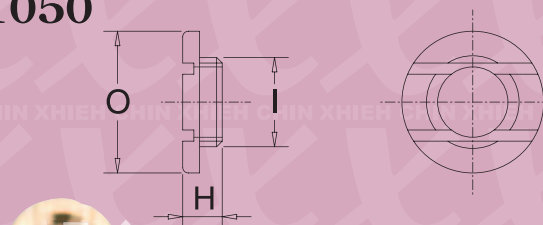

D1050 I*O*H

I	O	H
M8	12.7	3.54

D1054

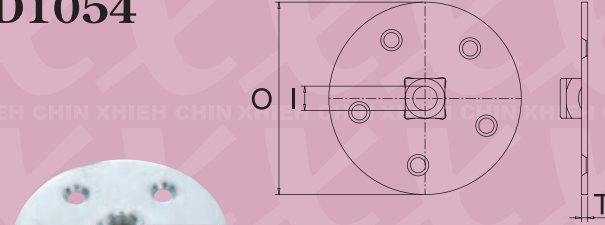

D1054 I*O*T

I	O	T
M8	63	2
M8	80	3

D1051

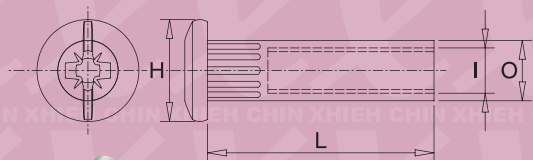

D1051 I*O*L*H

I	O	L	H
M6	8	30	13.5

D1055

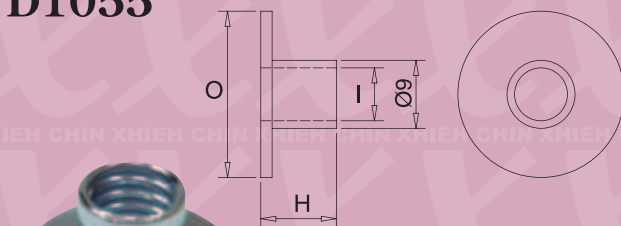

D1055 I*O*H

I	O	H
5/16	22	10